

**// NEW: Hörmann BiSecur**  
The modern radio system for garage door operators



## Series 2000 Garage Doors

Superior design, engineering excellence





The steel designs	6 - 7
The natural beauty of timber	8 - 9
Elegant and durable GRP doors	10 - 11
Open-for-infill door	12 - 13
Door renovations	14 - 15
Steel door designs and options	16 - 17
Timber door designs and options	18 - 19
GRP door designs and options	20 - 21
Safety features and safety check	22 - 23
Automated garage doors with electric operators	24 - 25
Fitting details	26 - 29
Overview	30 - 31

For more information on up-and-over doors and other high-quality Hörmann products, visit [www.hormann.co.uk](http://www.hormann.co.uk)

Some of the doors shown in this brochure have special features and therefore do not always represent the standard version.

The colours shown are subject to the limitations of the printing process and cannot be regarded as binding.

Copyright. No part of this brochure may be reproduced without our permission. Subject to changes.

We reserve the right to make changes to specifications without prior notification.

"A good name has to be earned."

August Hörmann, Founder, 1886–1944



## Our Name, Your Promise

You can trust Hörmann brand quality

As number 1 in Europe with over 20 million doors sold, only Hörmann can provide true quality in an up-and-over door. In line with the philosophy of the company's founder, the Hörmann brand remains a guarantee for quality. With sophisticated technology, numerous styles, and convenient and reliable operation, Hörmann has been setting standards for 75 years.

**Based on German engineering,  
assembled in the U.K.**

## Hörmann Series 2000 up-and-over doors

All doors and operator components are developed and manufactured by Hörmann. Hörmann Series 2000 garage doors are assembled at the Hörmann factory in Leicestershire from components sourced from both the continent and the U.K.

## Certified brand quality

Hörmann doors and operators are thoroughly adapted to each other and tested and certified by independent, recognised institutes to ensure your safety. They are produced in accordance with the quality management system DIN ISO 9001 and fulfil all the requirements of European standard 13241-1.

Please see pages 22-23 for all details.

## Be environmentally aware

Responsible use of resources and uncompromising implementation of environmental protection regulations are two of Hörmann's traditional top priorities. We have substantially reduced the energy required for production through ultra-modern systems and by using improved, environmentally-friendly processes. Hörmann will continue to follow and push forward with this philosophy in the future.

## Long-term performance

It goes without saying that Hörmann doors and operators are precisely matched and for your safety are tested by the TÜV (German Technical Inspectorate) and for compliance with the relevant standards.



\* The complete warranty conditions can be found at [www.hormann.co.uk](http://www.hormann.co.uk)

Our steel doors are available with the authentic appearance of natural timber, in a Golden Oak or Rosewood Decograin finish. The UV-resistant synthetic foil-coating will remain beautiful for a long time. Please see page 16 for the design selection.



## The classic designs in steel

Stylish designs - outstanding performance

Series 2000 steel doors are timeless in appearance, never ageing your property. Whether choosing one of the ribbed or panelled designs, they offer a quiet elegance blending in with any environment whilst giving a lasting prestige.

## Matching steel side doors



2001 Vertical      2004 Georgian      Vertical Decograin

Whether your garage is attached to the house or separate, you might be looking for a side door that perfectly matches your garage door.

### Many colour options and attractive timber surface finishes



Steel garage doors can be supplied in six colours from the RAL colour chart (see also page 17). Garage side doors can be supplied to colour match in the following colours: Terra brown, Ruby red, Steel blue and Moss green.

The Decograin surface finish is available in Golden Oak and Rosewood. The inside of the doors is always Grey white (RAL 9002).



For garage and side door glazing and handle options, see page 17.

### An expressive look and a lasting surface finish

The door is galvanised with a high-quality polyester powder-coating and comes protected against adverse weather conditions and corrosion, maintaining the long term beauty of the door.

Attention to detail and high quality joinery are the hallmarks of Hörmann Series 2000 timber doors. Each hand-crafted panel is secured into our open-for-infill leaf frame.



## The natural beauty of timber

Timber infills exquisitely crafted for a lasting appeal

Whatever the style of your property, traditional or modern architecture, our styles of timber doors in either panelled or tongued and grooved design, offer you the choice to find a style that will add warmth and character to your home. The carefully selected cedar wood is not only chosen for its aesthetic beauty but also for its natural durability, insulation and sound absorption.



## Matching timber side doors



2019 Garage Light    2008 Tudor    2020 Gatcombe

A matching side door might be exactly what you are looking for to complete the aesthetic appearance of your home!

## Fully finished colour options



You can blend in the door with the timber elements of your property. At Hörmann we offer 9 colour options as a fully finished factory coat.

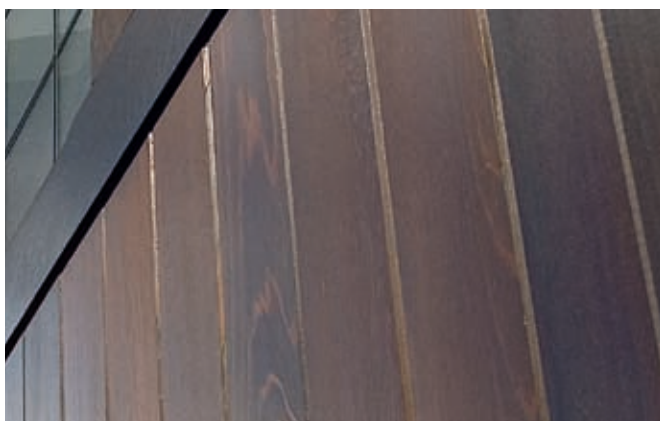
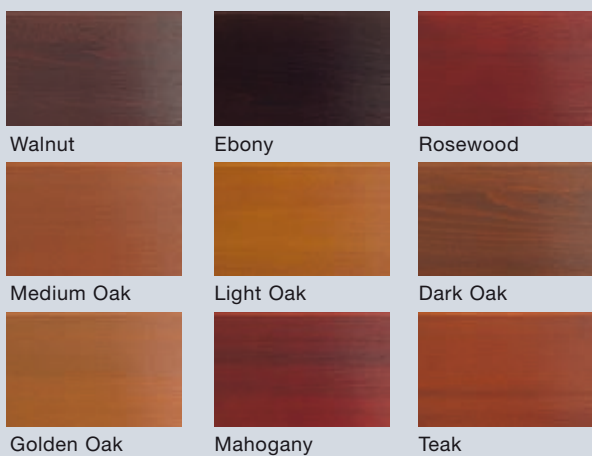

Wood needs protecting. That's why, in addition to the factory impregnation, it is important to apply a pigmented wood preservative to a timber garage door, in order to protect it against atmospheric influences and the effects of UV rays.

Glazing and handle options are available on page 17.

All our timber doors are carefully manufactured and supplied with a factory-finish dip immersion coat of Sikkens WP560 colour re 006 Light Oak for temporary protection, requiring an additional on-site finish. With wood being a natural product, any finish may vary and movement of components and joints may occur, particularly in changes of weather from very wet to hot sunshine. This is what gives your door its individual character.

Glass Reinforced Polyester, often referred to as fibreglass, is a tough and durable material. The door leaves are secured within our open-for-infill frame ensuring long-term stability.



## Elegant and durable GRP doors

Highly popular, easy to maintain

If low maintenance is an important factor to you, a Glass Reinforced Polyester door is just what you're looking for. While requiring minimum maintenance it will give you the long-lasting elegant look and character of genuine timber.

## The look of timber, the benefit of GRP

### A range of colours to choose from

Our GRP doors are available in a supersmooth, high gloss white finish and a variety of timber looks. You will surely find the right finish to complement all your architectural requirements.

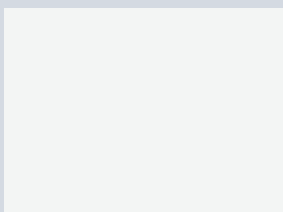

White supersmooth



White woodgrain

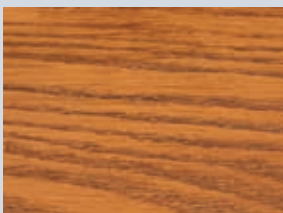

Cherry Oak woodgrain

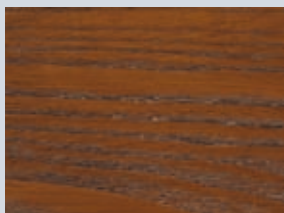

Countryside Oak woodgrain

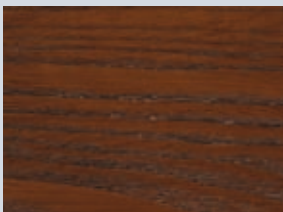

Dark Oak woodgrain



Mahogany woodgrain

There are many beautiful styles to choose from, offering the choice from rustic designs to modern panels. Available in five woodgrain finishes and white supersmooth. For all styles please refer to page 20.



The timber character surface finish of GRP doors is not only different by colour but also by its underlying appearance.

For colour and glazing options please refer to page 21.

Make your garage door invisible. The door can be integrated seamlessly in your facade design, with exclusive, flush-fitting panel cladding.



## Individual designs

The garage door for the highest architectural demands

With design 2011, you can create a garage front to fit your own ideas and personal architectural style. A steel frame construction open-for-infill is a solid technical basis to build on. You can pick an infill to fit your individual style. No other garage door can be integrated so harmoniously into an overall discerning facade design.

## Design your own door with the open-for-infill frame

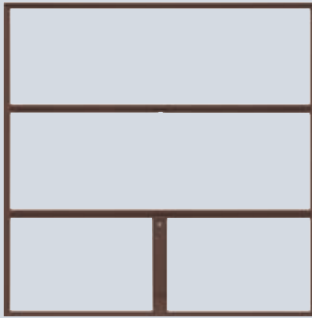

**2011 open-for-infill**  
Door width up to 4267 mm

The Hörmann open-for-infill leaf frame is perfectly prepared to accept a timber infill of your own design.

### This is the solid basis

- Extremely sturdy frame construction with reinforced struts. Fully welded!
- Min. infill weight: 6 kg per m<sup>2</sup>, max. infill weight 10 kg per m<sup>2</sup>.
- Fully galvanised, door leaf frame additionally with high-grade polyester primer coating Terra brown (RAL 8028) or Traffic white (RAL 9016).
- Frame and struts pre-drilled at 30 mm spacings.
- Illustrated fitting instructions with suggested designs.

This door construction offers you two design options:

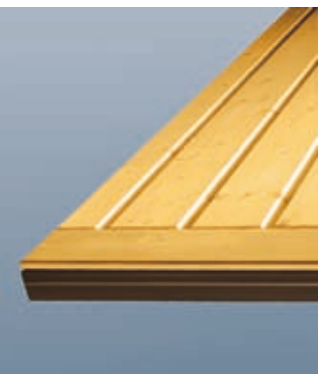

Infill overlapping the frame, whereby the frame and bottom section are entirely concealed.

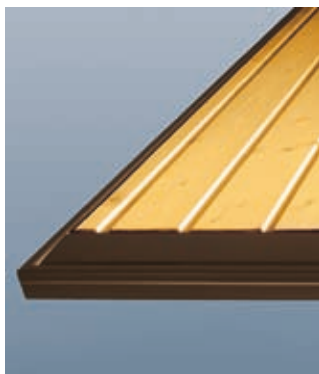

Timber infill within the frame with visible bottom section to protect against spray water.

With design 2011 open-for-infill, door widths of up to 5 m are possible (for any width over 4267 mm, please refer to the DF98 range) if the permissible infill weight is complied with.

**TIP:** Hörmann has numerous standard modernisation sizes that have been adapted exactly to older doors, that are to be replaced. These standard sizes save you money and also make it possible to install your new automatic garage door even faster.



## Out with the old - in with the new

Quick and clean and all on the same day

"We're pleased everything went so well. From the on-time delivery to the quick and clean fitting of the doors, we will definitely use Hörmann for our front door."

## Replacing your door is easy

### Fascia panels and renovation panels

In the case of renovations, the structural opening can sometimes be higher and wider than the lower-priced standard-sized garage door. Hörmann solves this problem by offering aesthetically-pleasing top and side fascia panels to close the gaps. If masonry is damaged on removing the old garage door, a renovation panel provides a neat solution without the need for any further plastering.



### Bottom rubber strip for an unbroken flat floor line (optional)

With the flexible rubber strip in place, this will help keep out passing debris.



### Optional retractable plus

Still conforming to the EN 13241-1 this gear allows for a clear drive through passage wider than the standard retractable gear. This makes parking the car in the garage a lot more convenient!



### Also purchase a matching operator

Opening the garage door is then much more convenient and automatic door locking secures it against forced opening.

### ProMatic Akku

The solution for a garage door operator in pre-fabricated garages and garage blocks without a power connection: A portable battery supplies the operator with power and can be charged inside the house via a normal power socket.

### The solar module

You should also enquire about the ProMatic Akku solar module. This then saves you having to charge the accumulator manually.



## Steel door designs

All our steel door designs come in Traffic white (RAL 9016) as standard, except for the open-for-infill frame which comes in Terra brown (RAL 8028). Choose from our range of colour options or Decograin surface finishes to match the architecture of your home.



2001 Vertical



2002 Horizontal



2601 Elegance



2003 Chevron



2103 Caxton



2101 Ilkley



2004 Georgian



2304 Georgian with window



2504 Countess



2104 Marquess

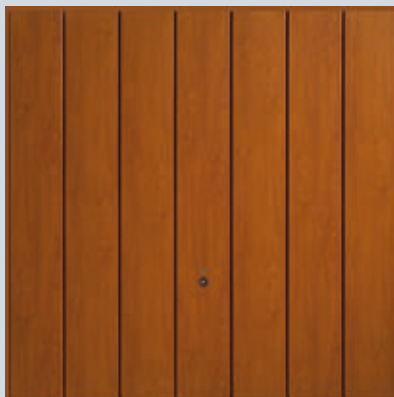

Vertical Decograin Golden Oak  
(available as Rosewood)

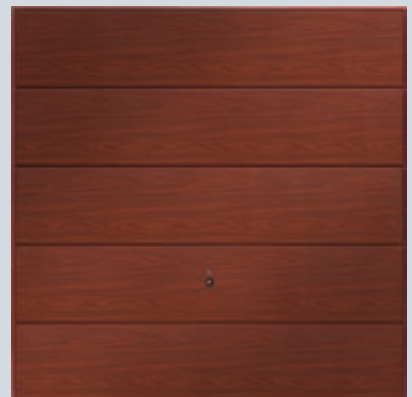

Horizontal Decograin Rosewood  
(available as Golden Oak)



# Steel door options

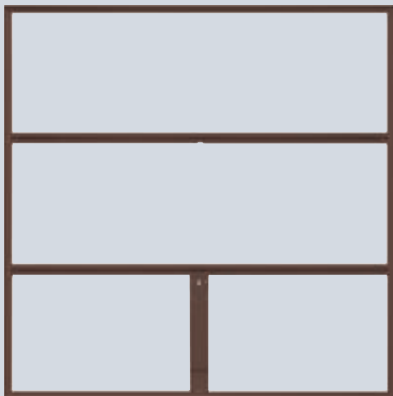

2011 Open-for-infill (available in Traffic white RAL 9016, not shown)



2001 Vertical



2004 Georgian

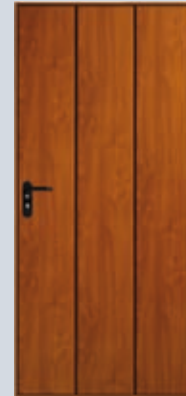

Vertical Decograin

Matching side doors are available for all steel designs except 2101, 2103, 2504.

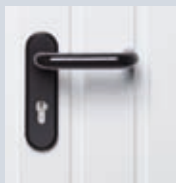

Side doors come with a profile cylinder lock and a black, synthetic lever/lever handle set as standard. They are available in the same material choices as the garage door handles. Optional lever/knob handle set available.

## Choose your favourite colour or a timber character

### Decograin surface finish



Moss green (RAL 6005)



Terra brown (RAL 8028)



Signal blue (RAL 5005)



Steel blue (RAL 5011)



Ruby red (RAL 3003)

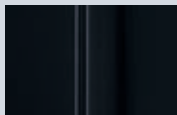

Jet black (RAL 9005)

Contact your Hörmann specialist dealer for advice regarding coloured doors.



Decograin Golden Oak\*

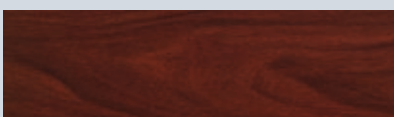

Decograin Rosewood\*

\* Decograin also available in Marquess and Georgian styles

## Choose from these options for Georgian windows



Plain



Diamond



Crossed

All windows come with crystal panes. Frames come white as standard with colour options available.

## A beautiful handle adds value

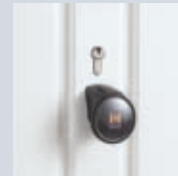

Synthetic black, standard

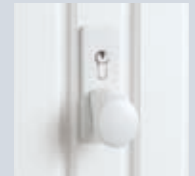

Cast aluminium, white

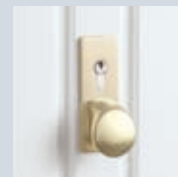

Cast aluminium, brass finish

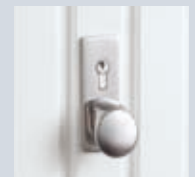

Polished stainless steel

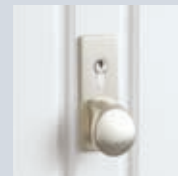

Cast aluminium, silver finish

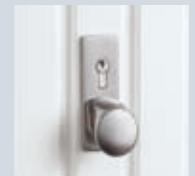

Brushed stainless steel

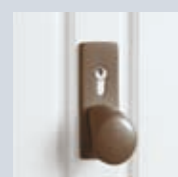

Cast aluminium, brown

## Timber door designs



2005 Measham



2007 Jacobean



2008 Tudor



2014 Rutland



2009 Vertical or Horizontal



2010 Chevron



2013 Caxton



2019 Garage Light



2020 Gatcombe



2019 Mallory (Horizontal or Vertical)



2114 Shepshed



2119 Leicester

# Timber door designs and options



2121 Chesterfield



2019 Garage Light



2008 Tudor

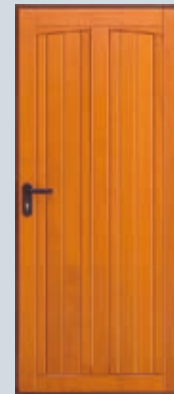

2020 Gatcombe

Matching side doors are available for all timber designs.



2122 Middleton

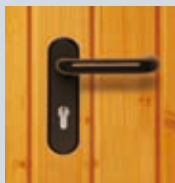

Side doors come with a profile cylinder lock and a black, synthetic lever/lever handle set as standard. They are available in the same material choices as the garage door handles. Optional lever/knob handle set available.

## Choose your favourite wood stain

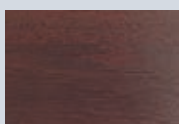

Walnut

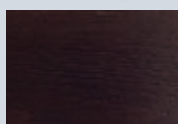

Ebony

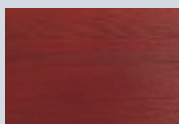

Rosewood

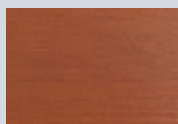

Medium Oak

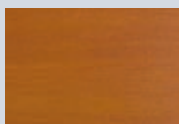

Light Oak

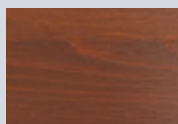

Dark Oak

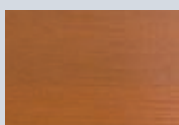

Golden Oak

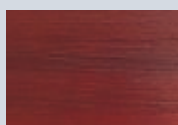

Mahogany

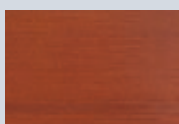

Teak

## Choose from these options for design 2019 Garage Light windows

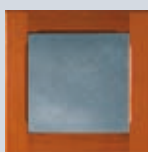

Plain

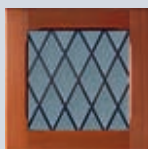

Diamond

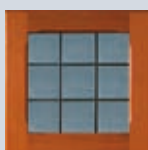

Crossed

The simulated 'leaded light' designs can be combined with a clear or stippled opaque pane. Panes are made of tough, durable perspex.

## A beautiful handle adds value

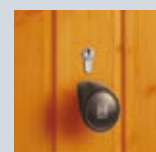

Synthetic black, standard



Cast aluminium, white

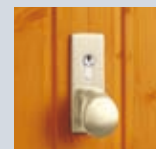

Cast aluminium, brass finish



Polished stainless steel

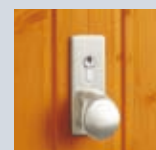

Cast aluminium, silver finish



Brushed stainless steel

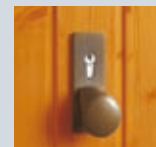

Cast aluminium, brown

# GRP door designs



2034 Peshurst



2035 Hartfield



2040 Livingston



2041 Coniston



2042 Windermere



2044 Stamford



2047 Bourton



2048 Burford



2049 Moreton



2041 Coniston with windows



2042 Windermere with windows

# GRP door options

Choose your door finish and colour

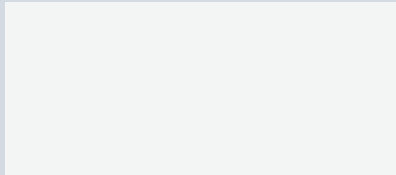

White supersmooth ■

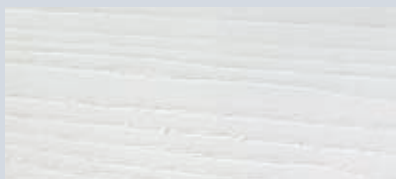

White woodgrain □

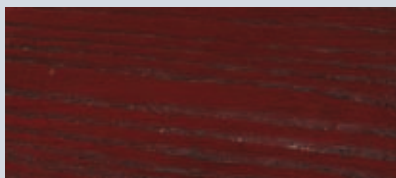

Mahogany woodgrain ○

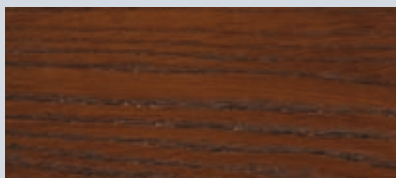

Dark Oak woodgrain ●

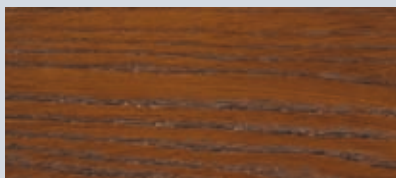

Countryside Oak woodgrain ▲

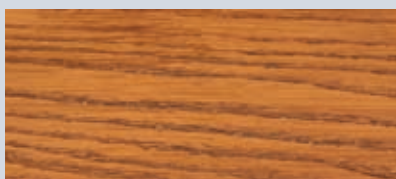

Cherry Oak woodgrain △

Choose from these options for Coniston, Windermere and Stamford windows



Plain



Crossed



Diamond

The simulated 'leaded light' designs can be combined either with a translucent or clear pane.



Stamford



Stamford

2044 Stamford is supplied with black glazing as standard and translucent as an option. All panes are made of tough, durable, perspex.

A beautiful handle adds value

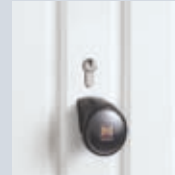

Synthetic black, standard

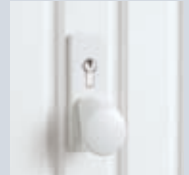

Cast aluminium, white

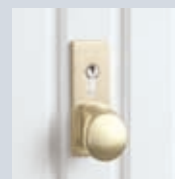

Cast aluminium, brass finish



Polished stainless steel

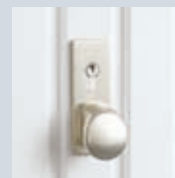

Cast aluminium, silver finish

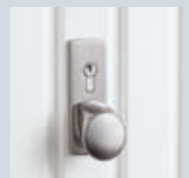

Brushed stainless steel

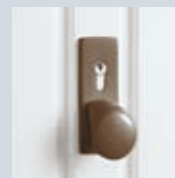

Cast aluminium, brown

# Safety features to the latest European Standard 13241-1

## The retractable gear for single and double garage doors



**1** Finger-trap protection



**2** Track roller well



**3** Spring system

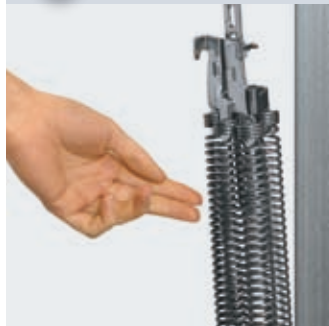

### Safety checklist

For your old retractable up-and-over door



- Do flexible plastic strips on the frame and door leaf prevent trapped fingers? **1**
- Is there a safety distance of 25 mm between the lifting arm and the frame? **1**
- Does the bearing bracket have protective caps to prevent injury if inadvertently reached into? **1**
- Is the door safely and securely guided as well as protected against uncontrolled movements? **2**
- Are the tracks designed in such a way that it is impossible for the rollers to derail? **2**
- After opening, does the door come to a safe stop? **2**
- Is the door leaf safeguarded against crashing to the floor? **3**
- Is it guaranteed that even if a spring should break, an imbalance no greater than 200 N is produced? **3**
- Are the springs safeguarded to prevent them from being catapulted into the air? **3**
- Is the spring system designed in such a way that there is no risk of trapped fingers? **3**
- On power-operated up-and-over doors: are the maximum closing forces to EN 13241-1 complied with?

**Even if you have answered only one of the above with "no", your door is no longer safe.**

### Easy fitting saves time

Hörmann offers a steel fixing frame for all single and double retractable doors. This frame makes an on-site timber frame redundant and saves valuable installation time as it is quick and easy to fit.



**The retractable double door**



### 4-point locking

If even more security is required, a 4-point locking arrangement is available as a factory-fitted optional extra, or it can be retro-fitted. On single doors only.

## Safety features to the latest European Standard 13241-1 The canopy gear for single doors

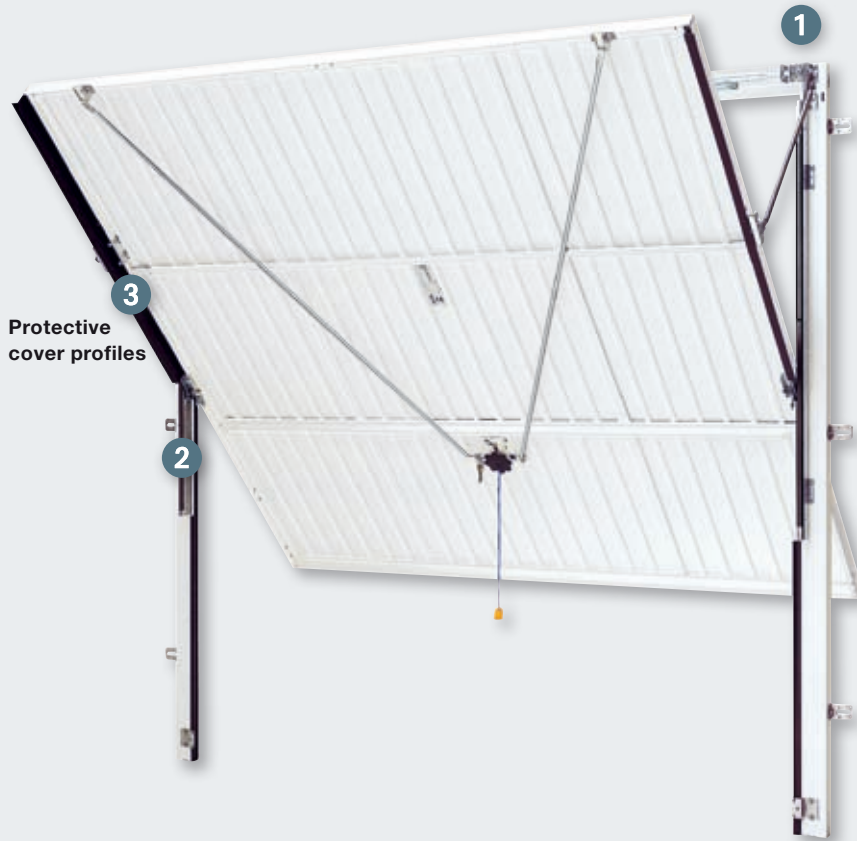

Protective cover profiles

### Safety checklist For your old canopy up-and-over door



- Is there an anti-fall safeguard fitted to your present door to prevent injury if a cable breaks? **1**
- Is the door safely and securely guided as well as protected against uncontrolled movements? **1**
- Are the tracks designed in such a way that it is impossible for the rollers to derail? **1**
- After opening, does the door come to a safe stop? **1**
- Are the door's cables internally guided? **2**
- Do protective cover strips on the frame and the door leaf prevent trapped fingers? **2**
- Does your door have a cable drum with deep grooves to ensure the cable fits securely and prevents cables jumping? **4**

**Even if you have answered only one of the above with "no", your door is no longer safe.**

**1** Cable drum



**3** Internally guided cables

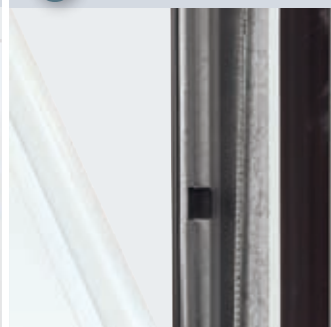

**4** Anti-fall safeguard



### Easy fitting saves time

Hörmann offers a steel fixing frame for all canopy doors. This frame makes an on-site timber frame redundant and saves valuable installation time as it is quick and easy to fit.



### 4-point locking

If even more security is required, a 4-point locking arrangement is available as a factory-fitted optional extra, or it can be retro-fitted. On single doors only.

**TIP:** Always on hand in your car – inconspicuously located in the cigarette lighter. An inexpensive alternative to integrated remote control systems. To operate either one (HSZ 1) or two (HSZ 2) functions.



## Systematic opening

Intelligent accessories for comfort and safety

When it comes to opening and closing garage doors, Hörmann offers a wide range of accessory components with numerous functions. Radio operation is either possible from within the vehicle or from any other mobile location. In addition, individual high-tech solutions, such as fingerprint recognition, increase safety and convenience.



## Accessories



**HS 5 BS**  
**hand transmitter // NEW**  
4-button functions plus inquiry button available in black and white; full scope of function only with SupraMatic and ProMatic operators.



**HSE 2 BS**  
**hand transmitter // NEW**  
2-button functions incl. key ring, available in black and white



**HSP 4 BS**  
**hand transmitter**  
4-button functions, with button lock-out, incl. key ring



**HS 4 BS**  
**hand transmitter // NEW**  
4-button functions only available in black



**HS 1 BS**  
**hand transmitter // NEW**  
1-button function only available in black



**HSZ 1 BS**  
**hand transmitter**  
One button function, for insertion in vehicle cigarette lighter

**HSZ 2 BS**  
2-button functions, for insertion in vehicle cigarette lighter



**HSD 2-A BS**  
**hand transmitter**  
Aluminium look, 2-button functions, can also be used as a key ring

**HSD 2-C BS**  
High-gloss chrome, 2-button functions, can also be used as a key ring

To find more accessories and information on Hörmann operators for garage doors and entrance gates, please see the special brochures or go to [www.hormann.co.uk](http://www.hormann.co.uk)



Hörmann automatic doors are as easy to operate as a television. Just press the button and drive into your garage while staying protected from the wind and rain. A direct entrance is also safer for you at night.



### ProMatic

The inexpensive starter model as an introduction to Hörmann's premium quality, for a maximum of 12 door cycles (open/close) per day. Opening speed: 14 cm/s.

#### ProMatic

For doors up to 5000 mm wide (max. 11 m<sup>2</sup> door surface)  
Peak force: 750 N

#### ProMatic Akku

For garages not connected to the mains supply and doors up to 3000 mm wide (max. 8 m<sup>2</sup> door surface)  
Peak force: 400 N



### SupraMatic

The high-quality operator with an array of additional functions, for a maximum of 50 door cycles\* (open/close) per day. Opening speed: 22 cm/s.

- Halogen lighting can be switched on/off separately
- Partial opening facility for a well ventilated garage

#### SupraMatic E

For doors up to 5500 mm wide (max. 13,75 m<sup>2</sup> door surface)  
Peak force: 650 N

#### SupraMatic P

As standard incl. photocell  
For doors up to 6000 mm wide (max. 15 m<sup>2</sup> door surface) heavy timber doors and sectional doors with wicket doors.  
Peak force: 1000 N

\* based on SupraMatic P

The SupraMatic operator comes with the black HS 5 BS 5-button hand transmitter and with a black 2-button HSE 2 BS hand transmitter. The ProMatic comes with two black 2-button HSE 2 BS hand transmitters.



### Power Operated Garage Doors

It is against the law to install a power operated garage door in the UK without complying with the Machinery Directive. To comply with the Machinery Directive both the door and the operator used in the installation must have a Declaration of Incorporation from the manufacturer. On completion of the installation the installer must provide a Declaration of Conformity and apply a CE mark giving details of the installation to the door/operator combination, which is now classed as a machine. The installer must issue to the customer a Declaration of Conformity on completion of the installation. The installer must hold copies of both the Declaration of Incorporation and the Declaration of Conformity on a technical file for inspection by the relevant authorities. If any of the above requirements are not fulfilled the installation is illegal. Please ensure for your own safety and peace of mind that whoever installs your electric operator is both willing and able to fulfil these requirements; if they are not - do not use them!



Members of the DHF Garage Door Installer Group can and will install your Hörmann operator safely and legally.

# Fitting details for Series 2000 retractable gear for single doors

## Position of anchors

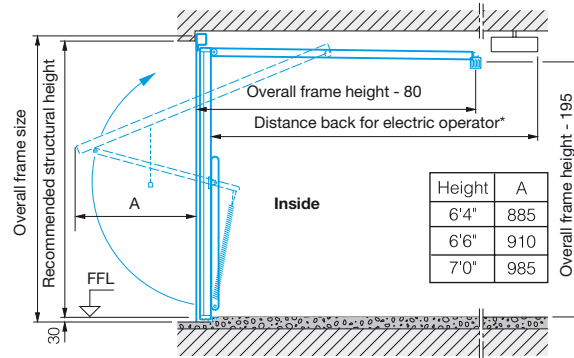
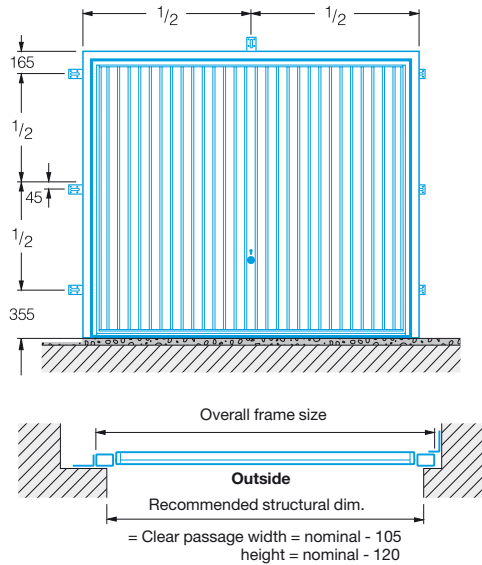

\* Distance back for ProMatic/SupraMatic electric operator:  
 3200 mm up to door height 2500 mm  
 3450 mm up to door height 2750 mm

## Fitting behind the opening

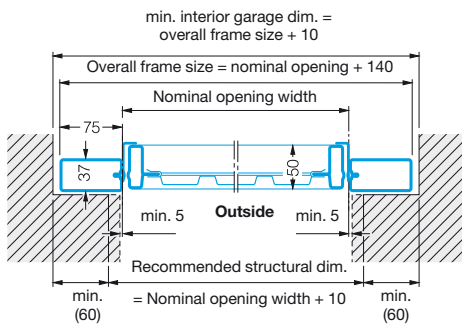

The recommended structural dimensions are recommended planning dimensions. Minimum sideroom, headroom and opening sizes are all based on these dimensions.

## Door with flat floor

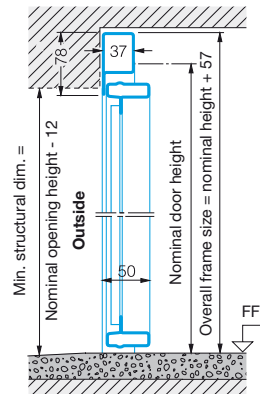

### With ProMatic/SupraMatic operator

No additional headroom required.  
 Exception: some timber designs allow 15 mm clearance.

## Fitting in the opening

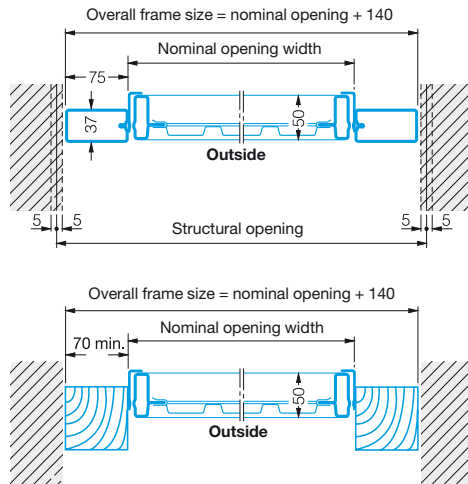

Fitting in the opening requires that the given dimensions be adhered to with greater accuracy.

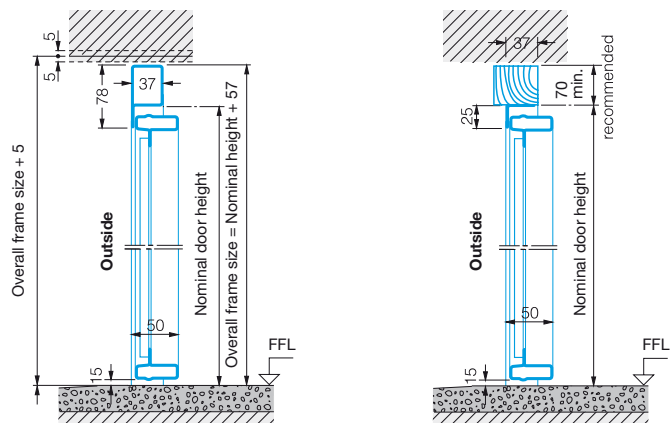

### With ProMatic/SupraMatic operator

No additional headroom required.  
 Exception: some timber designs allow 15 mm clearance.

# Fitting details for Series 2000 canopy gear for single doors

## Position of anchors

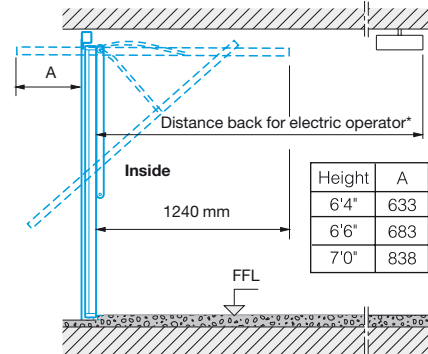
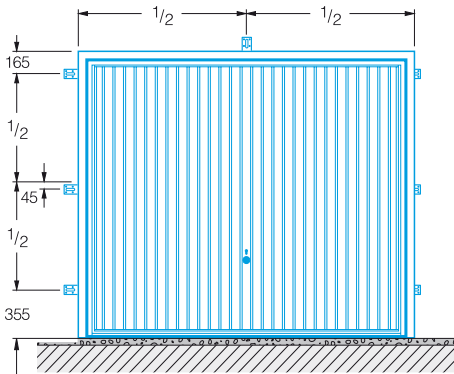

## Clear passage

Width: nominal opening less 40 mm (1½") only within bottom 1/3 due to flexible seals.  
 Height: nominal door height - 140

For doors with operator 40 mm headroom above top crossframe required. (Overall frame size + 40 mm)

## Fitting behind the opening

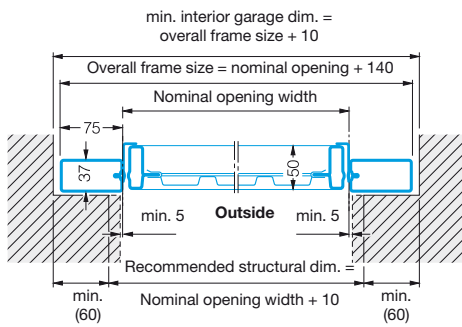

Behind opening installation with the Hörmann steel frame allows for a wider range of structural openings to be spanned, this can be particularly helpful with non-standard openings which would normally require special sized doors. The diagrams show the minimum tolerances that should be adhered to. PLEASE NOTE: the overall frame sizes are shown as additions to the nominal opening sizes.

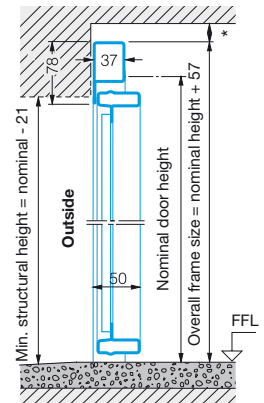

\* 40 mm headroom required for operator

## Fitting in the opening

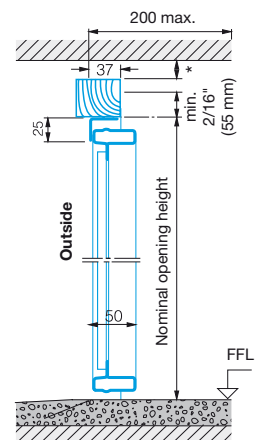
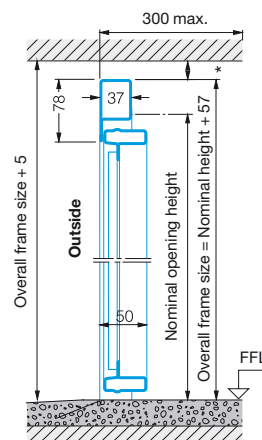
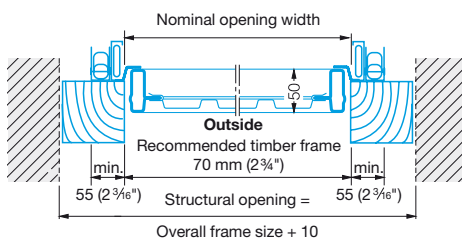
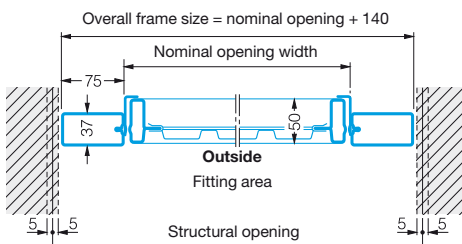

\* 40 mm headroom required for electric operator

The size chart gives the structural opening sizes for each door size, this frame is the standard 2¾" (70 mm) square. A narrow application gear is provided for doors to be fixed to timber frames allowing the frame to be a minimum of 2⅝" (55 mm) square if required, allowing the door to be fitted to smaller structural opening. For electric operation with canopy door a bow arm must be purchased separately. **For overall dimensions of Hörmann steel frame, add 5½ (140 mm) to nominal opening width and 2¼ (57 mm) to nominal opening height.**

# Fitting details for Series 2000 retractable gear for double doors

## Position of anchors

Dimensions in mm

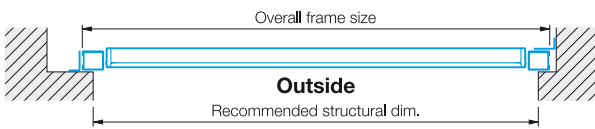
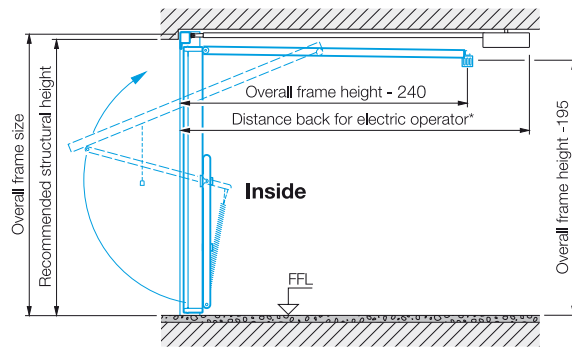
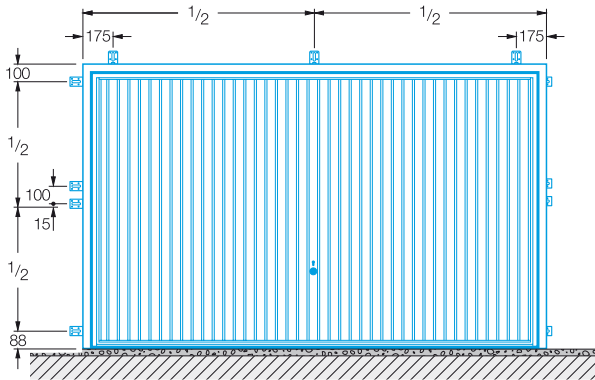

\* Distance back for electric operators:  
 3200 mm up to door height 2500 mm ProMatic/SupraMatic  
 3450 mm up to door height 2750 mm ProMatic/SupraMatic

## Fitting behind the opening

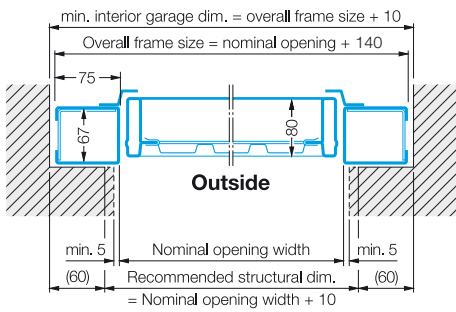

### Door with flat floor

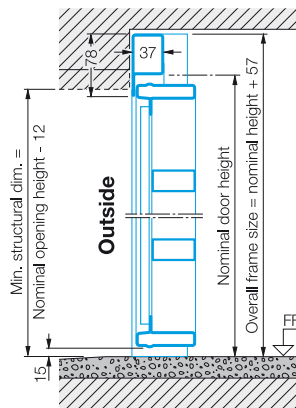

The recommended structural dimensions are recommended planning dimensions. Minimum sideroom, headroom and opening sizes are all based on these dimensions.

### With ProMatic/SupraMatic operator

No additional headroom required.  
 Exception: some timber designs allow 15 mm clearance.

## Fitting in the opening

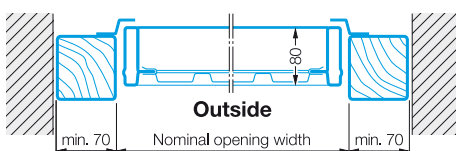
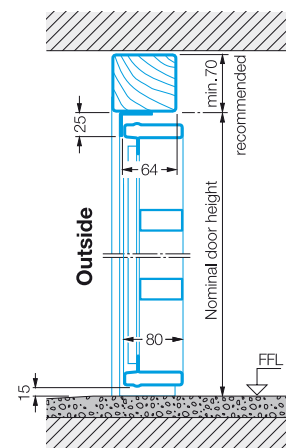
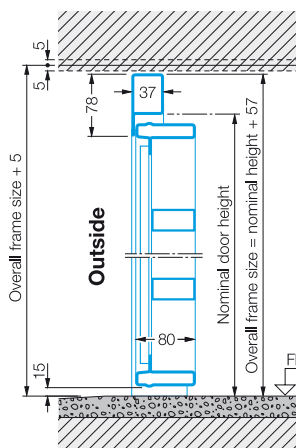
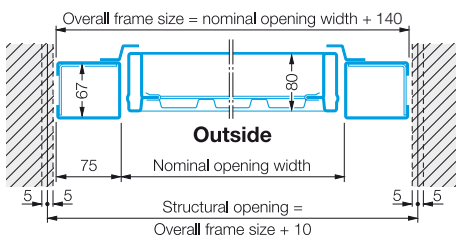

Fitting in the opening requires that the given dimensions be adhered to with greater accuracy.

### With ProMatic/SupraMatic operator

No additional headroom required.  
 Exception: some timber designs allow 15 mm clearance.

# Fitting details for Series 2000 garage side doors

## Single leaf

Position of anchors

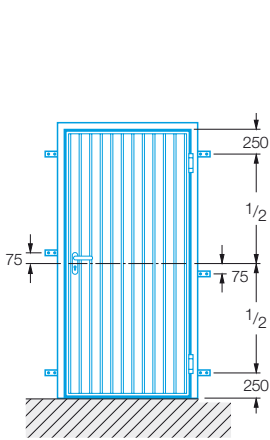

Single leaf door with stepped floor

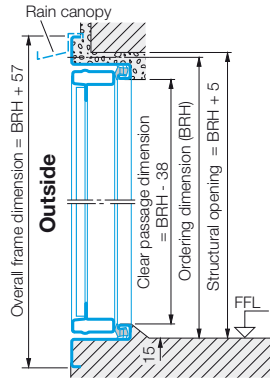

Single leaf door (supplied with bottom threshold as standard, will be removed on site)

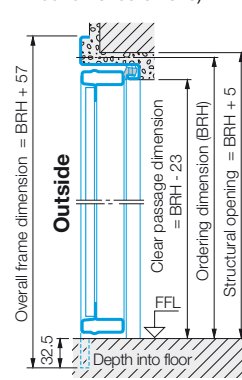

Single leaf door (supplied without bottom threshold)

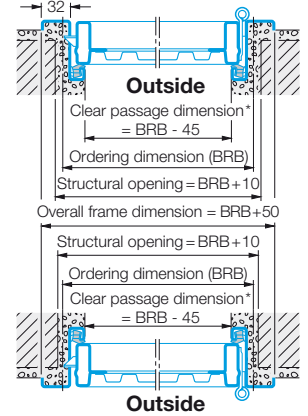
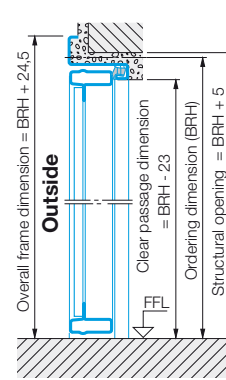

Standard sizes for single-leaf doors				Dimensions in mm			
Ordering size (BR)		Structural opening		Clear passage dimensions			Height of lever handle
Width	Height	Width	Height	with threshold	without threshold	from FFL	
875	1875	885	1880	830	1837	1852	990
875	2000	885	2005	830	1962	1977	1050
875	2125	885	2130	830	2087	2102	1110
1000	2000	1010	2005	955	1962	1977	1050
1000	2125	1010	2130	955	2087	2102	1110

**Single leaf doors**  
Standard sizes with steel infill and open-for-infill frames are supplied for external fitting as standard. For internal fitting, fittings can be reversed. Designs with timber infill for external fitting only.

\* With an opening angle of less than 180°, the clear passage width is reduced.

Block frame for fitting into the opening: dimensions and versions on request.

Maximum size range (BR): 1250 x 2375 mm.

## Double leaf

Position of anchors

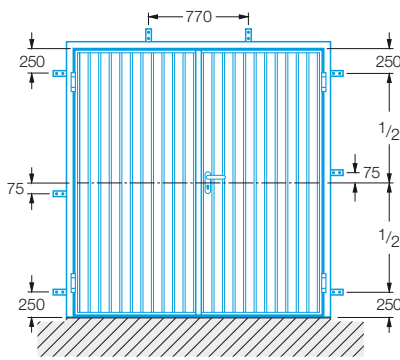

Door with flat floor

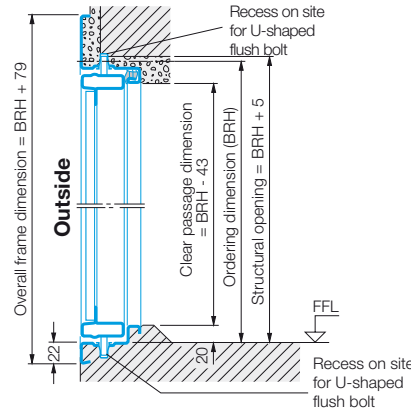

Door with stepped floor

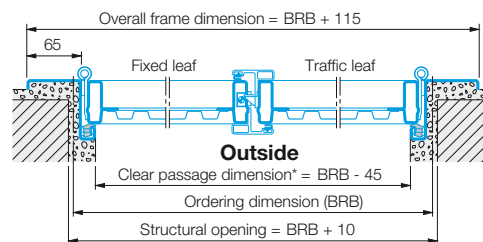
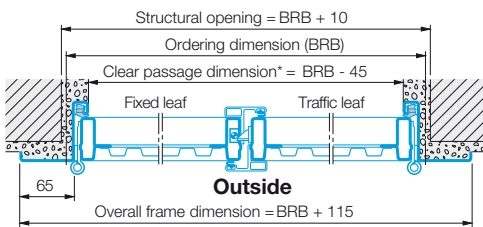
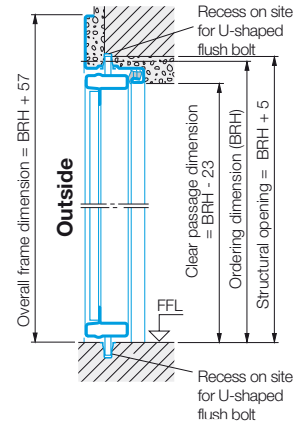

\* With an opening angle of less than 180°, the clear passage width is reduced.

Block frame for fitting into the opening: dimensions and versions on request.

**Double leaf doors**  
Supplied as standard for external fitting, traffic leaf on the right. State on order if internal fitting or left hand traffic leaf is required. Equal division of leaves only.

**Size range for double-leaf doors**  
Width (ordering size): from 1300 to 2500 mm  
Height (ordering size): from 1750 to 2250 mm  
Panelled designs only up to BRB = 2000 mm

### Single leaf, external fitting (standard)



### Double leaf, external fitting (outside)

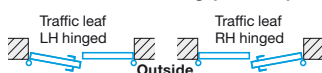

### External fitting

With threshold profile.

### Single leaf, internal fitting



### Double leaf, internal fitting



### Internal fitting

For internally fitted doors, the threshold angle/transport angle should always be removed. Adequate water drainage to the outside must then be ensured. For doors on the weather side external fitting is preferable.



**Experience quality with  
Hörmann**

## Entrance doors

Comprehensive entrance door ranges to fit almost every need and requirement.



## Canopies

A practical complement to your chosen entrance door.

## Steel doors

Quickly fitted: Solid doors for all areas in your home, from the basement to the loft.



## Frames

Choose from our comprehensive programme for new construction, renovation and modernisation.

## Garage doors

The perfect match for your personal architectural style: up-and-over or sectional doors made of steel or timber.



## Door operators

Enjoy convenience: Hörmann operators for garage doors and entrance gates.

# Hörmann: Quality without Compromise



Hörmann KG Amshausen



Hörmann KG Antriebstechnik



Hörmann KG Brandis



Hörmann KG Brockhagen



Hörmann KG Dissen



Hörmann KG Eckelhausen



Hörmann KG Freisen



Hörmann KG Ichtershausen



Hörmann KG Werne



Hörmann Genk NV, Belgien



Hörmann Alkmaar B.V., Niederlande



Hörmann Legnica Sp. z o.o., Polen



Hörmann Beijing, China



Hörmann Tianjin, China



Hörmann LLC, Montgomery IL, USA



Hörmann Flexon, Leetsdale PA, USA

Hörmann is the only manufacturer worldwide that offers you a complete range of all major building products from one source. We manufacture in highly-specialised factories using the latest production technologies. The close-meshed network of sales and service companies throughout Europe, and activities in the USA and China, make Hörmann your strong partner for first-class building products, offering “Quality without compromise”.

**GARAGE DOORS**  
**OPERATORS**  
**INDUSTRIAL DOORS**  
**LOADING EQUIPMENT**  
**HINGED DOORS**  
**DOOR FRAMES**

